

CORRUBIT bitumena viļņoto lokšņu montāža

PIELIETOJUMS:

JUMTIEM AR MINIMĀLO SLĪPUMU 9%,

UZ JEBKURAS TĒRAUDA VAI KOKA KONSTRUKCIJAS

SVARĪGI! PIEMĒROTS TIKAI SAIMNIECĪBAS ĒKĀM, ŠĶŪŅIEM, DĀRZA MĀJĀM, GARĀŽĀM.

IZMĒRI:

GARUMS: 200 CM

PLATUMS: 93 CM

BIEZUMS: 2,2 MM

VIĻŅU AUGSTUMS: 36 MM

KRĀSAS:



CORRUBIT viļņoto lokšņu montāža

NEPIECIEŠAMIE CORRUBIT ELEMENTI

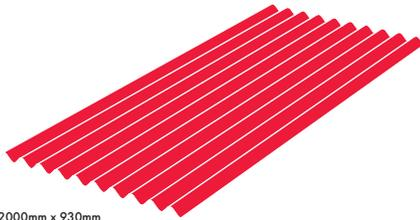

2000mm x 930mm
CORRUBIT VIĻŅOTĀS LOKSNES



1000mm x 450mm
CORRUBIT KORES



1000mm x 130mm x 200 mm
CORRUBIT VĒJMALAS



CORRUBIT NAGLAS
PIESKAŅOTĀS KRĀSĀS

NEPIECIEŠAMIE DARBARĪKI



AIZSARGCIMDI



AIZSARGBRILLES



EĻĻOŠANAS
AĒROSOLS



IESKATIES
PADOMOS
3. LAPĀ

ROKAS ZĀĢIS AR
"RUPJIEM" ZOBIEM



VAI



ELEKTRISKAIS
ZĀĢIS



ĀMURS



MĒRLENTA

NOSKATIES MONTĀŽAS VIDEO

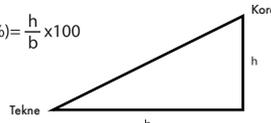

APRĒĶINI SAVA JUMTĀ SLĪPUMU

$$\text{Slīpums (\%)} = \frac{h}{b} \times 100$$

Minimālās jumta slīpuma prasības: 9%

JUMTA SLĪPUMI: Atbilstošos intervālus, lūdzu, skatiet zemāk.

9-17 %

17-27 %

> 27 %

a) MAKSIMĀLAIS LATOJUMA SOLIS



Jumta klājs (OSB)

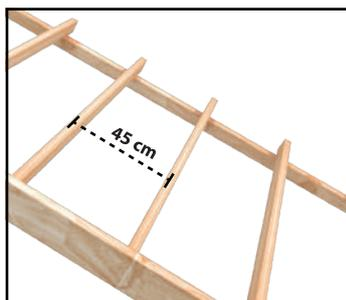

45 cm vai jumta klājs

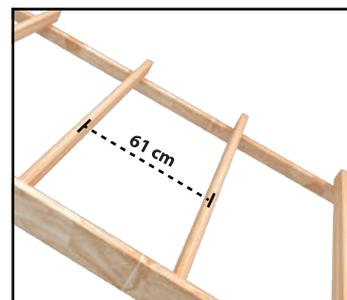

61 cm vai jumta klājs



b) MINIMĀLAIS GALU PĀRLAIDUMS

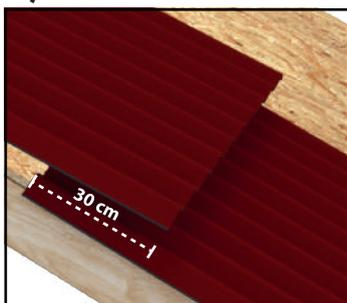

30 cm

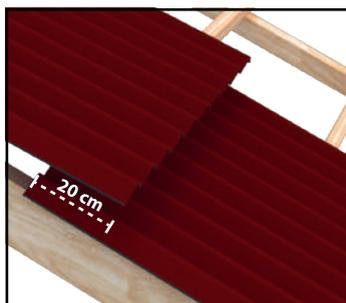

20 cm

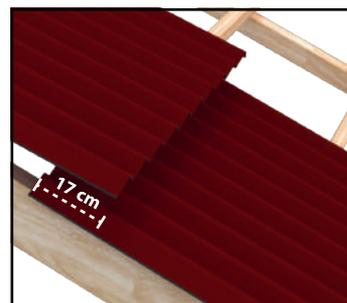

17 cm



b) MINIMĀLAIS SĀNU PĀRLAIDUMS



2 viļņi



1 vilnis

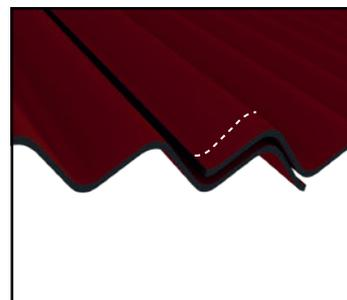

1 vilnis



Nestaigājiet pa jumtu!

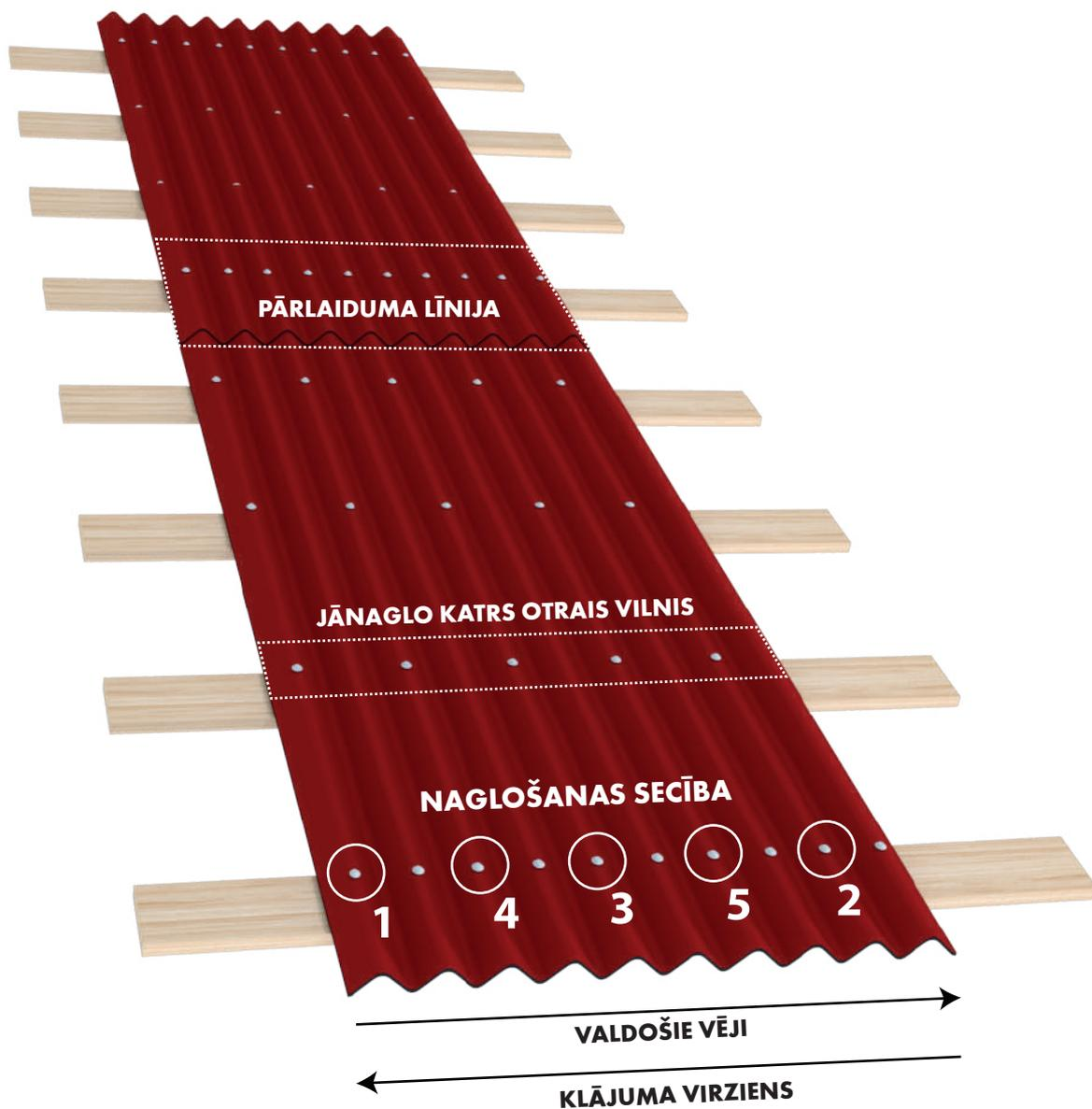

PRECĪZA NAGLOŠANA

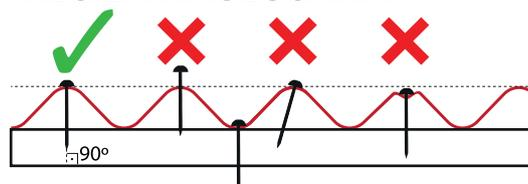

(12-20-30 cm) var mainīties
atkarībā no jumta slīpuma

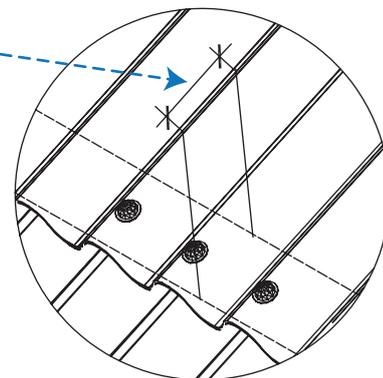
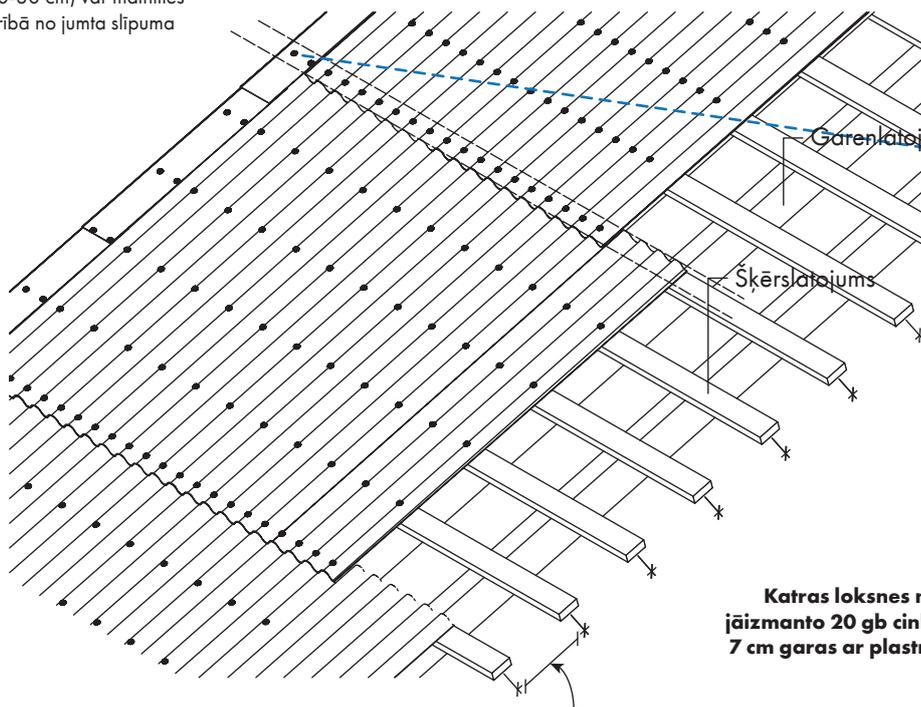

**Katras loksnes naglošanai
jāizmanto 20 gb cinkotas naglas -
7 cm garas ar plastmasas galviņu**

(45 vai 61 cm) var mainīties
atkarībā no jumta slīpuma

NĀKAMĀJĀS RINDĀS IZKĀRTOJUMS
PAR PUSLOKSNĪ JĀNOBĪDA,
TĀPĒC OTRĀ RINDĀ JĀUZSĀK
AR PUSI NO LOKSNES

LOKSNES JĀKLĀJ PRETĒJI
VALDOŠĀ VĒJA VIRZIENAM

KLĀJUMA VIRZIENS

VALDOŠĀ VĒJA
VIRZIENS

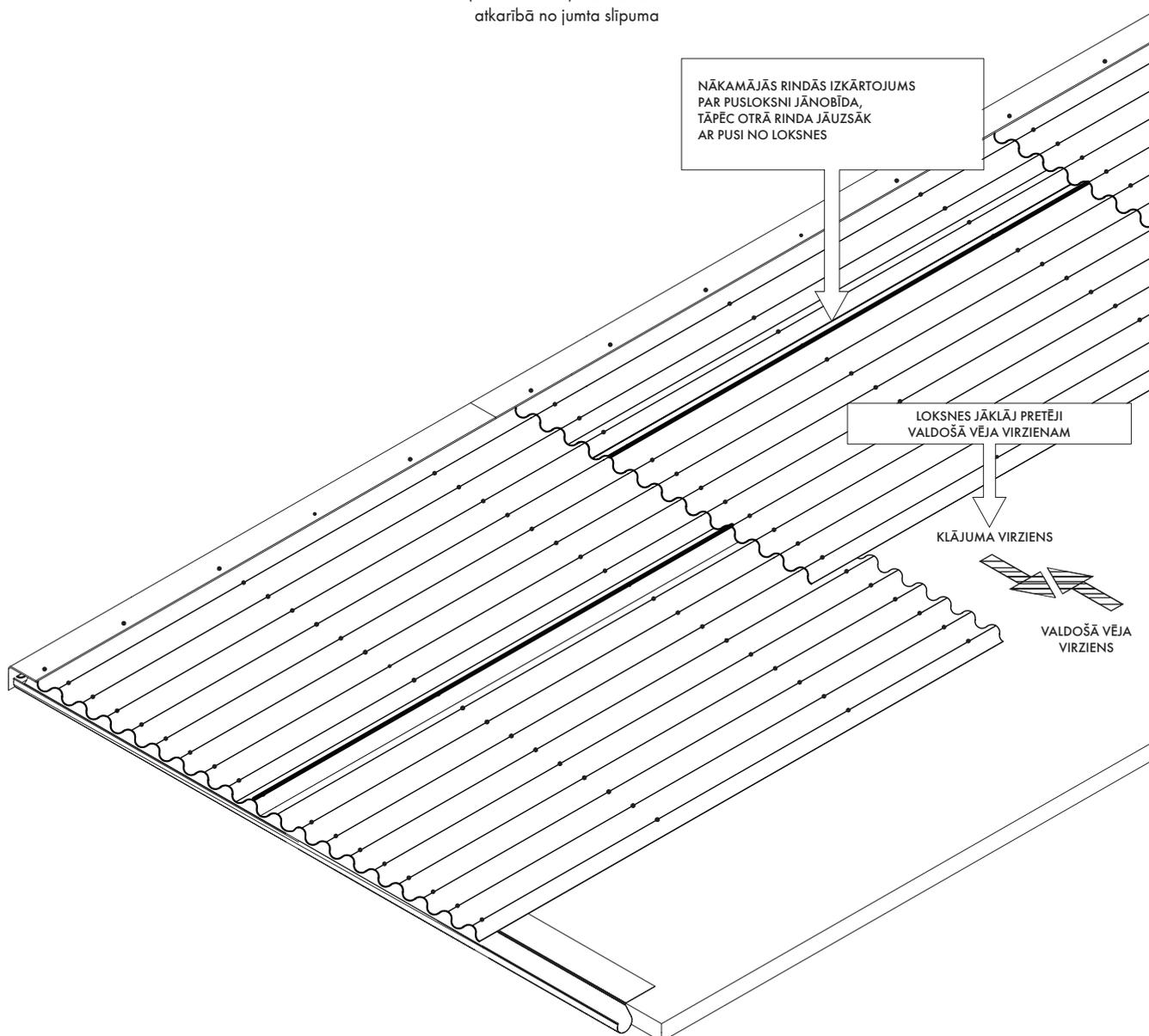

SVARĪGI!

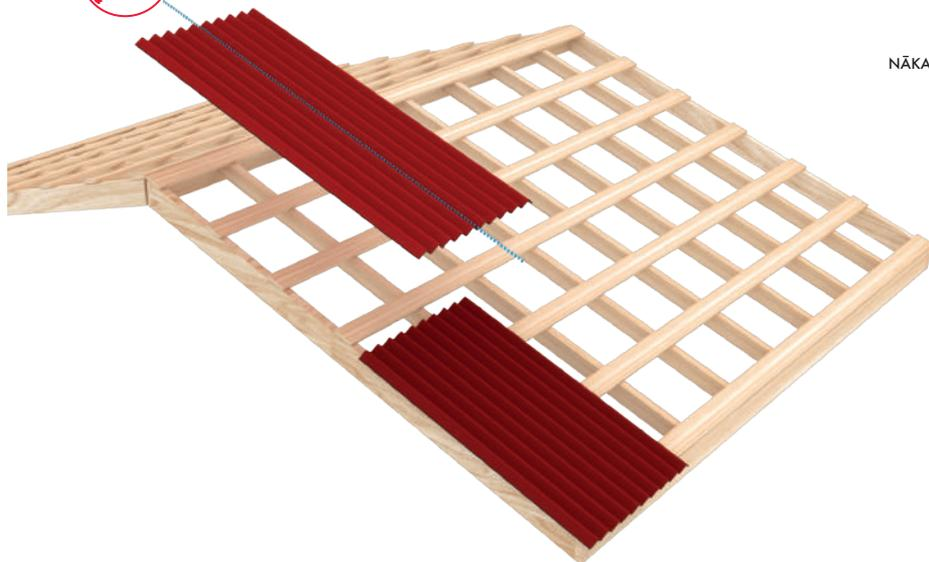

NĀKAMĀJĀS RINDĀS IZKĀRTOJUMS PAR PUSLOKSNI JĀNOBĪDA

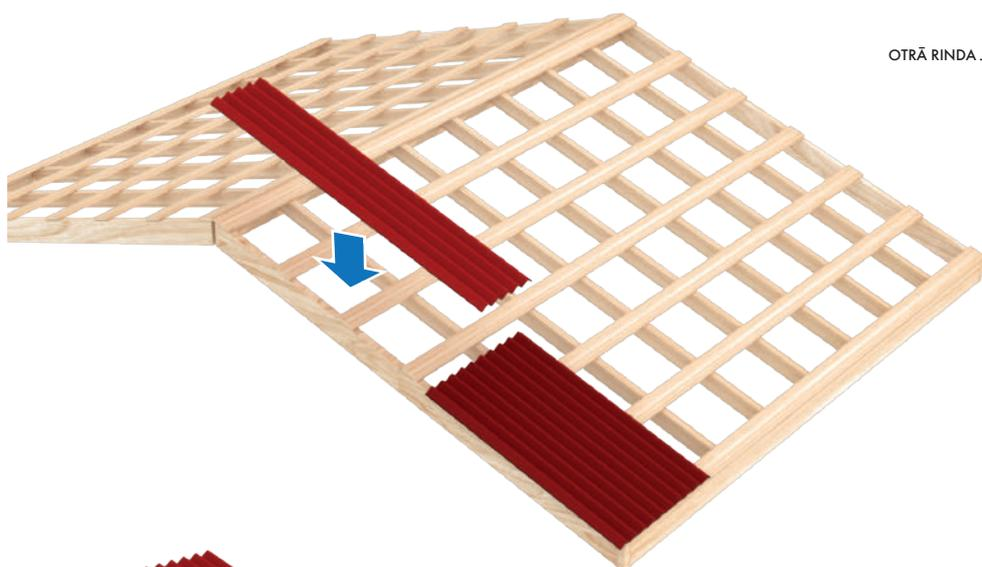

OTRĀ RINDA JĀUZSĀK AR PUSI NO LOKSNES

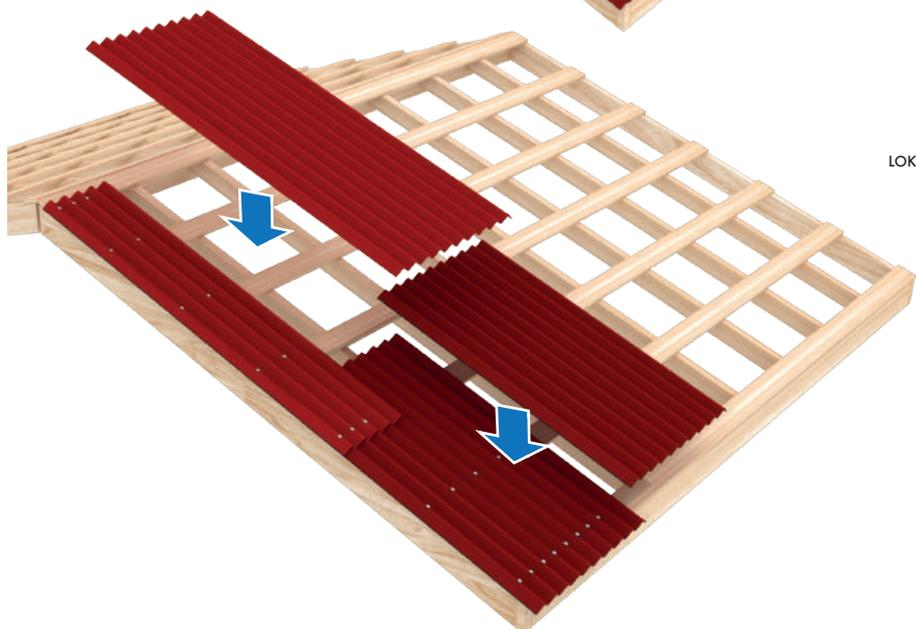

LOKSNES JĀKLĀJ PRETĒJI VALDOŠĀ VĒJA VIRZIENAM

MONTĀŽA

1

NOMĒRIET JUMTU

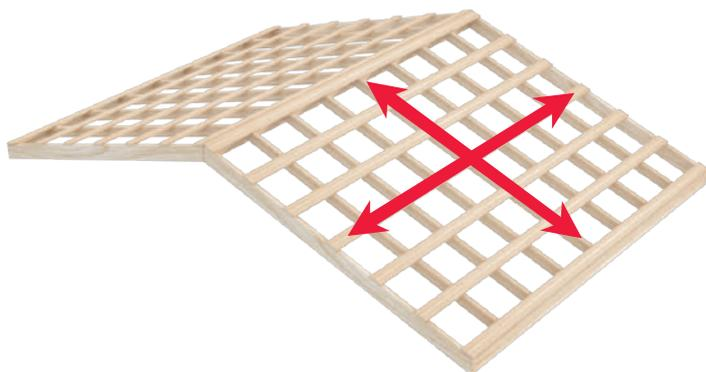

2

MONTĒJIET PIRMO
CORRUBIT VIĻŅOTO
LOKSNI

JĀNAGLO KATRA VIĻŅA AUGŠPUSĒ

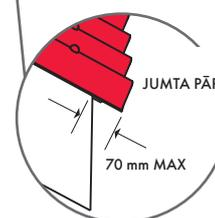
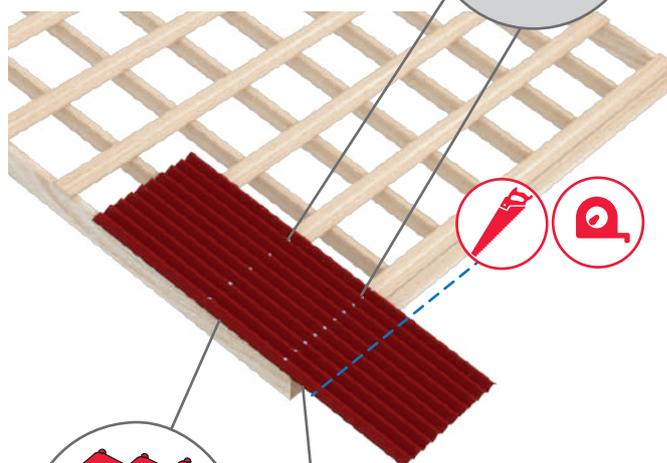
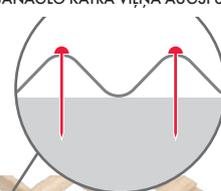

3

MONTĒJIET OTRU
CORRUBIT VIĻŅOTO
LOKSNI

LOKSNES JĀPĀRKLĀJ PAR VISMĀZ 2 VIĻŅIEM

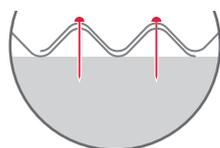

JUMTA SLĪPUMAM, UZ KURA TIKS UZKLĀTAS CORRUBIT BITUMENA VIĻŅOTĀS
JUMTA SEGUMA LOKSNES, JĀBŪT NE MAZĀKĀM PAR 9%.

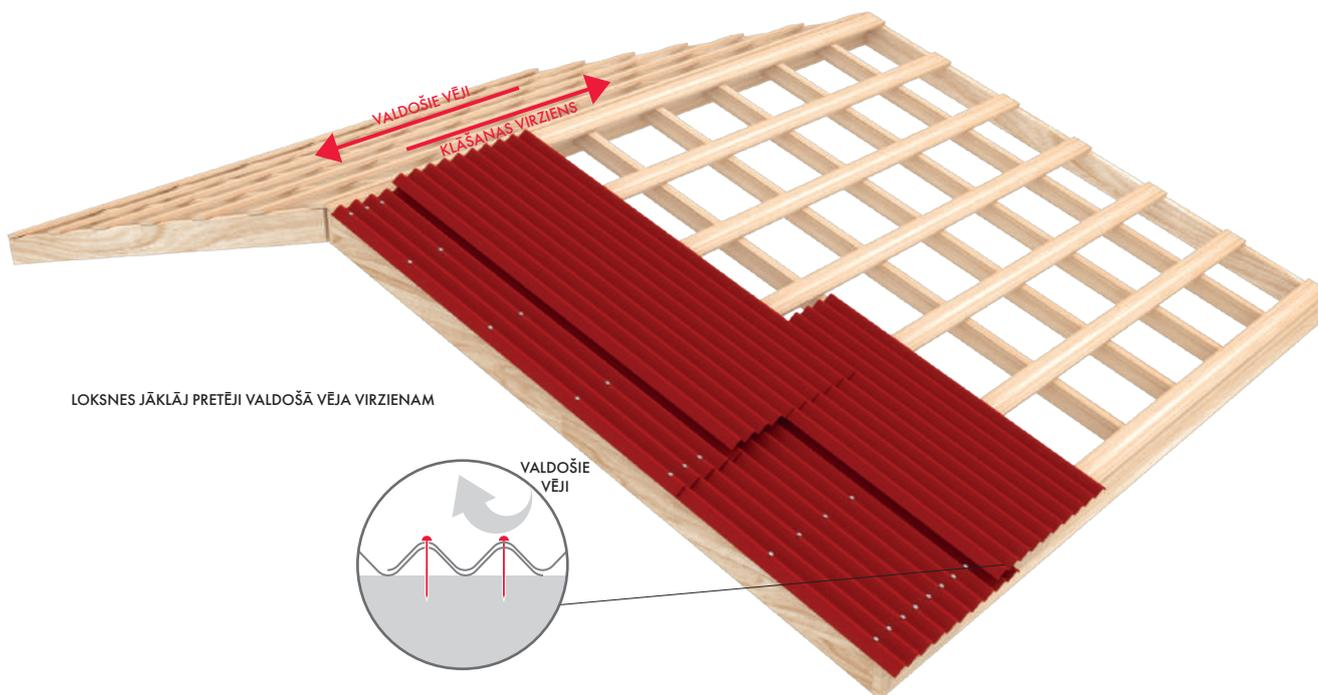

LOKSNES JĀKLĀJ PRETĒJI VALDOŠĀ VĒJA VIRZIENAM

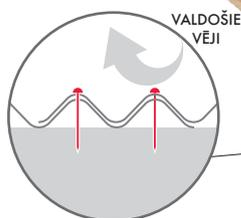

MONTĀŽA

4

MONTĒJIET PĒDĒJO
CORRUBIT VIĻŅOTO
LOKSNI

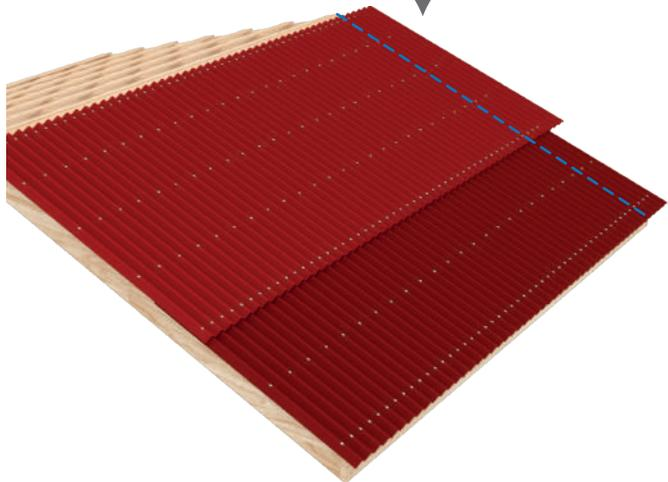

5

NOLOKĪET UN PIENAGĻOJIET
JUMTA MALAS

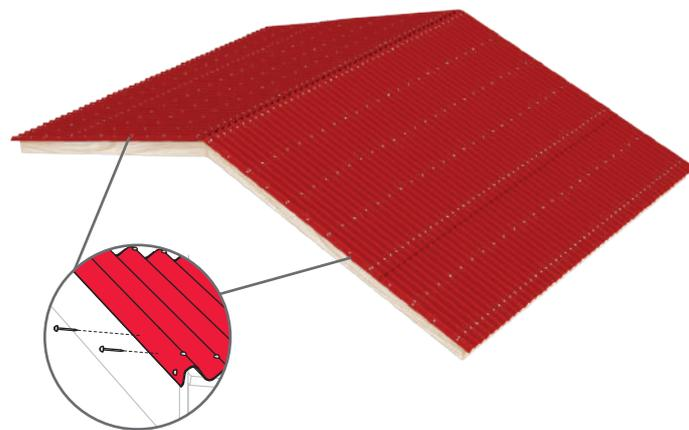

6

MONTĒJIET
CORRUBIT
VĒJMALAS

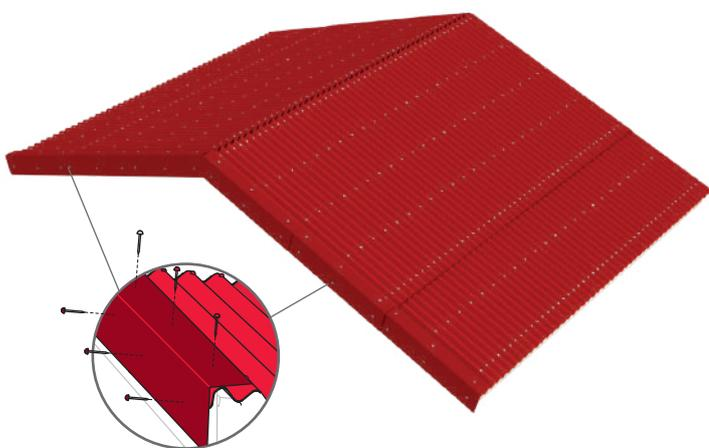

7

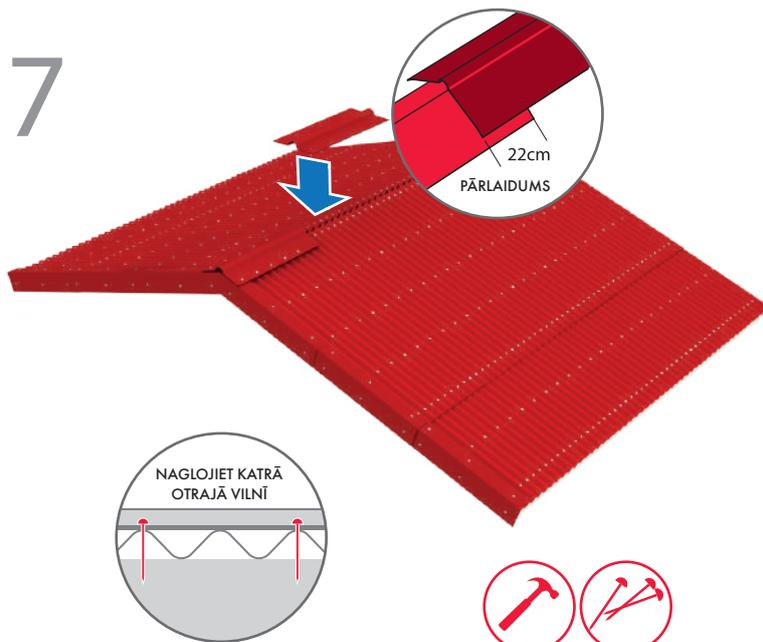

8

PĀBEIDZIET
MONTĀŽU

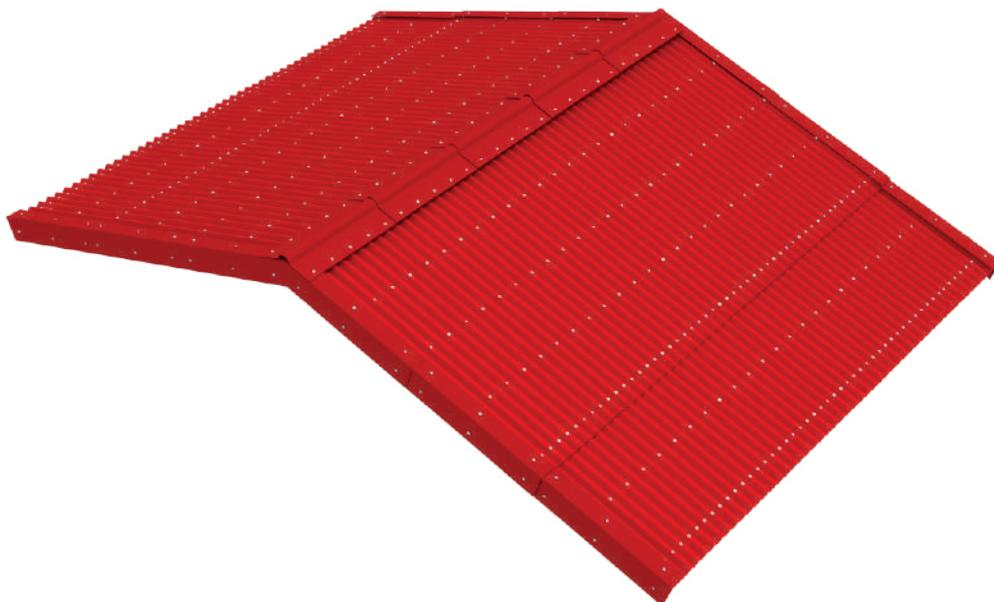

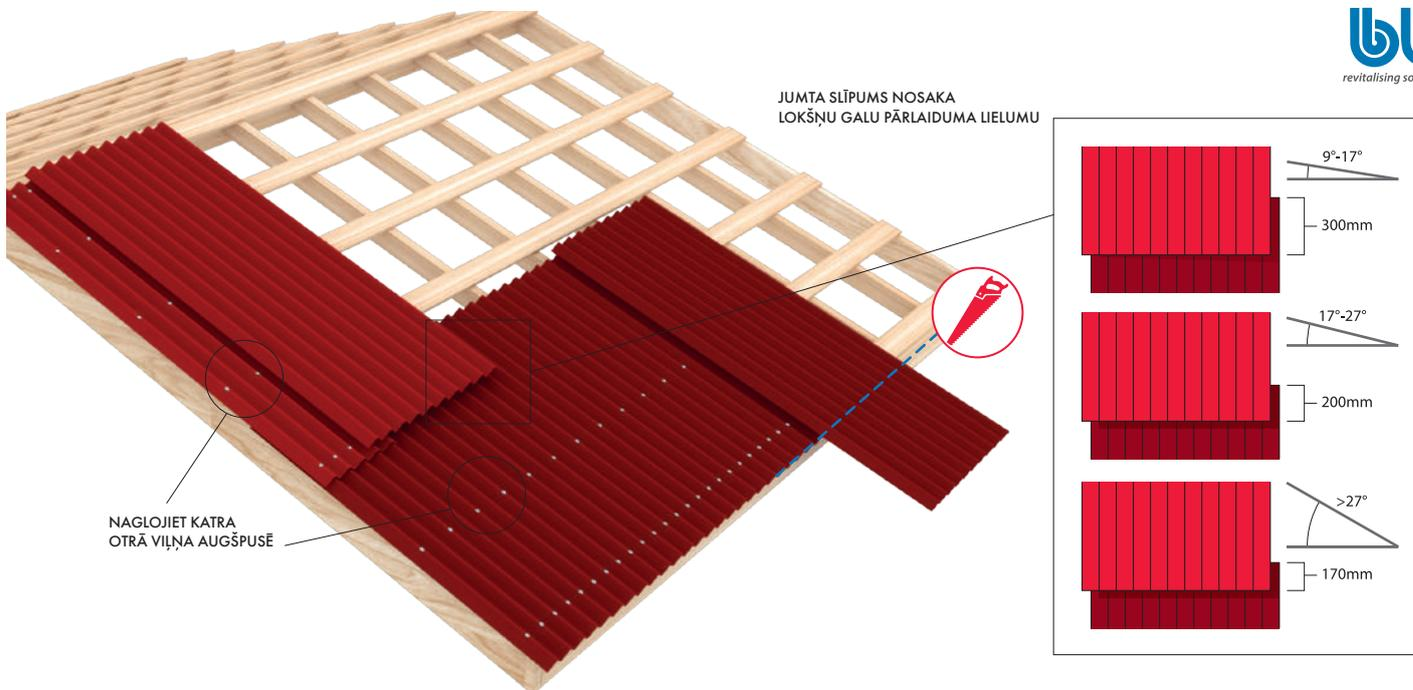

CORRUBIT bitumena viļņoto lokšņu montāža

SVARĪGĀKIE PADOMI

1

IZVAIRĪETIES VEIKT VERTIKĀLUS IEGRIEZUMUS! JA NEPIECIEŠAMS, TAD PĀRKLĀJIET VAIRĀK KĀ 2 LOKSNES VIĻŅUS TĀ, LAI PRECĪZI NOKLĀTU JUMTA PLAKNI.

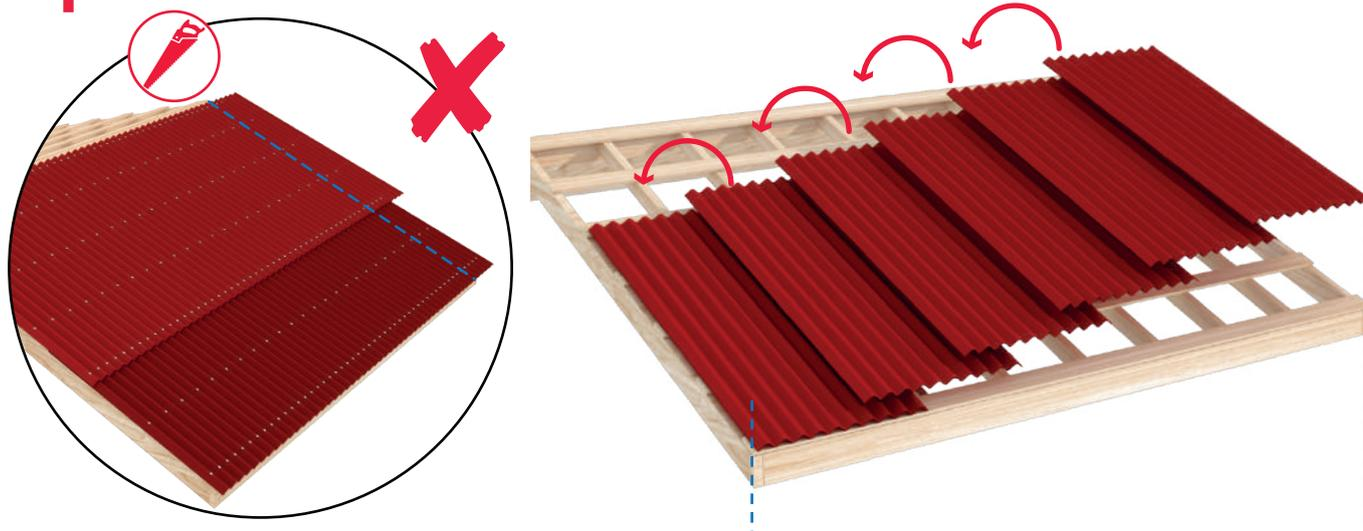

2

PIRMS HORIZONTĀLO GRIEZUMU VEIKŠANAS UZSMIDZINIET ZĀGA ASMENIM NEDAUDZ EĻĻOŠANAS AEROSOLA – TAS IEVĒROJAMI ATVIEGĻOS DARBU.

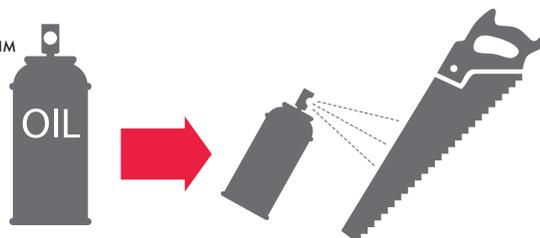

3

SVARĪGĪ! LAI JŪSU JAUNAIS JUMTS BŪTU ŪDENSNECAURLAIDĪGS UN AIZSARGĀTS PRET LAIKAPSTĀKĻIEM, VIENMĒR NAGLOJIET JUMTA LOKSNES CAUR VIĻŅA AUGSTĀKO PUNKTU, NEVIS CAUR VIĻŅA ZEMĀKO PUNKTU.

